

Pro-Crown International Co. Ltd.

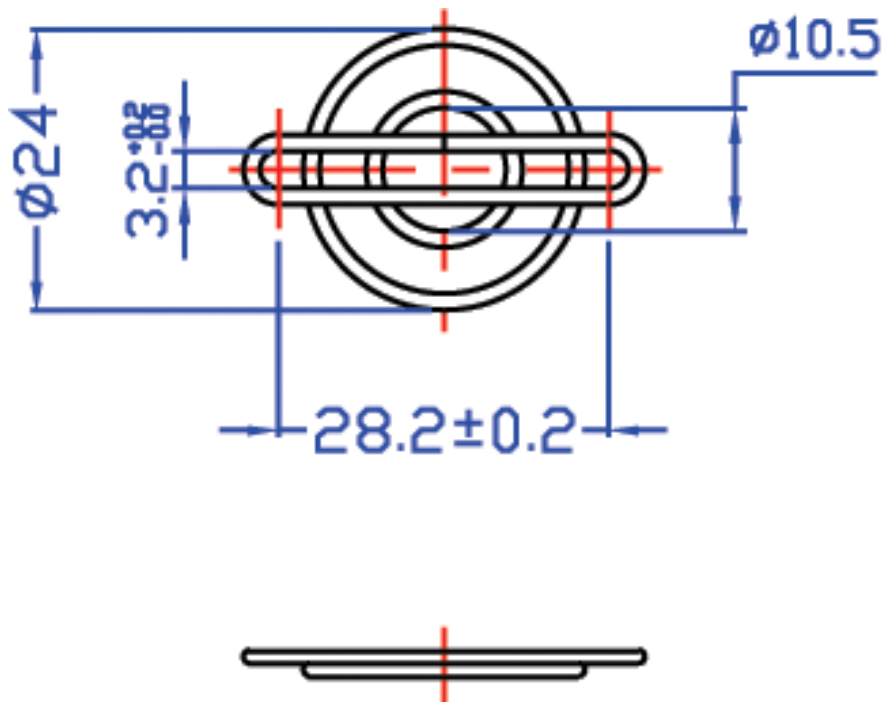

NOTES:

1. MATERIAL: C1008 BRIGHT BASIC WIRE.
2. FINISH: BRIGHT NICKEL CHROME.
3. (1) RINGS ARE $\phi 1.4$ mm.
(2) RIBS ARE $\phi 1.4$ mm.
4. WELD JOINTS TO WITHSTAND 88 LBS PULL FORCE.
5. SPACING BETWEEN RINGS TO BE EQUIDISTANT 3.95mm.
6. GENERAL TOLERANCE UNLESS NOTED: ± 0.5 mm.
7. PART MEETS $\phi 6.35$ mm PLUG GAUGE TEST.
8. UNIT: mm.